



DOMINA PRO 700 - ELEMENTS NEUTRES

**N77T**



## TOP

### SPÉCIFICATIONS TECHNIQUES:

|                                    |                          |
|------------------------------------|--------------------------|
| Dimensions exterieure - LxPxH (cm) | 70x73x25                 |
| Tiroir                             | <input type="checkbox"/> |

### SPÉCIFICATIONS SUPPLÉMENTAIRES:

|             |     |
|-------------|-----|
| Poids (kg)  | 25  |
| Volume (m3) | 0,3 |

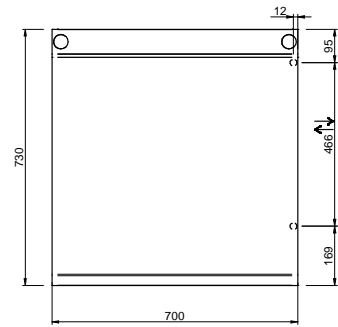
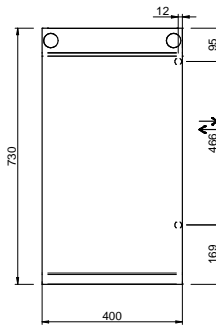
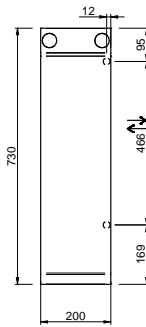
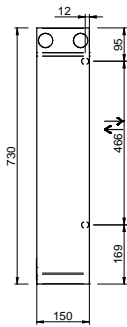
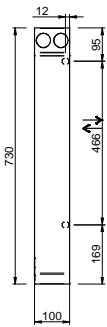
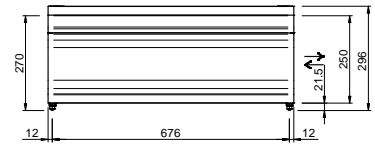
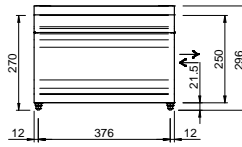
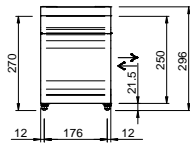
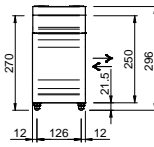
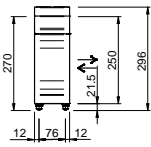

LEGENDA SIMBOLI / LEGEND



INGRESSO GAS / GAS INLET  
(EN 10226-1) Ø M 1/2"



INGRESSO ACQUA /  
WATER INLET Ø M 1/2"



ATTACCO EQUIPOTENZIALE /  
EQUIPOTENTIAL



ALIMENTAZIONE ELETTRICA /  
POWER SUPPLY



SCARICO ACQUA / OLII  
WATER / OILS DRAIN



REGOLAZIONE PIEDINI /  
FEET ADJUSTMENT (h 0/+50)  
/ TOP VERSION (h 0/+5)